

LF 25 . 2.0	25	2.0	2.5	0.930	0.730	0.0970	0.721	0.833	0.890	1.77
LF 25 . 2.5	25	2.5	2.5	1.15	0.901	0.0968	0.741	0.841	0.897	1.77
LF 25 . 3.0	25	3.0	3.0	1.35	1.06	0.0961	0.765	0.833	0.898	1.77
LF 30 . 1.5	30	1.5	1.6	0.862	0.677	0.118	0.820	1.03	1.07	2.12
LF 30 . 2.0	30	2.0	2.5	1.13	0.887	0.117	0.845	1.01	1.07	2.12
LF 30 . 2.5	30	2.5	2.5	1.40	1.10	0.117	0.866	1.02	1.07	2.12
LF 30 . 3.0	30	3.0	3.0	1.65	1.30	0.116	0.889	1.01	1.08	2.12
LF 30 . 4.0	30	4.0	6.0	2.10	1.65	0.113	0.953	0.934	1.06	2.12
LF 40 . 2.0*	40	2.0	2.5	1.53	1.20	0.157	1.10	1.36	1.42	2.83
LF 40 . 3.0*	40	3.0	3.0	2.25	1.77	0.156	1.14	1.36	1.43	2.83
LF 40 . 4.0*	40	4.0	6.0	2.90	2.28	0.153	1.20	1.28	1.41	2.83
LF 50 . 2.0*	50	2.0	3.0	1.93	1.51	0.197	1.35	1.70	1.77	3.54
LF 50 . 3.0*	50	3.0	6.0	2.81	2.21	0.194	1.41	1.62	1.76	3.54
LF 50 . 4.0*	50	4.0	8.0	3.67	2.88	0.191	1.46	1.57	1.75	3.54
LF 60 . 3.0*	60	3.0	6.0	3.41	2.68	0.234	1.66	1.97	2.11	4.24
LF 60 . 4.0*	60	4.0	8.0	4.47	3.51	0.231	1.71	1.92	2.10	4.24
LF 60 . 5.0*	60	5.0	10.0	5.48	4.30	0.229	1.77	1.88	2.10	4.24
LF 80 . 4.0*	80	4.0	8.0	6.07	4.76	0.311	2.21	2.63	2.82	5.66
LF 80 . 5.0*	80	5.0	10.0	7.48	5.87	0.309	2.26	2.58	2.81	5.66
LF 80 . 6.0*	80	6.0	12.0	8.85	6.95	0.307	2.32	2.54	2.80	5.66
LF 100 . 5.0*	100	5.0	8.0	9.52	7.48	0.391	2.75	3.35	3.54	7.07
LF 100 . 6.0*	100	6.0	10.0	11.3	8.87	0.389	2.80	3.30	3.53	7.07
LF 100 . 7.0*	100	7.0	12.0	13.0	10.2	0.387	2.86	3.25	3.53	7.07
LF 120 . 5.0*	120	5.0	8.0	11.5	9.05	0.471	3.25	4.06	4.24	8.49
LF 120 . 6.0*	120	6.0	10.0	13.7	10.8	0.469	3.30	4.01	4.24	8.49
LF 120 . 7.0*	120	7.0	12.0	15.8	12.4	0.467	3.36	3.96	4.24	8.49

(*) Perfil utilizable en edificación.

Tabla 5 2 Perfiles abiertos normalizados - Perfil L de alas iguales - Momentos

PERFIL	Referencia al X-X=Y-Y			I_{xy} cm ⁴	Referido al eje Z-Z			Referido al eje V-V		
	$I_x=I_y$ cm ⁴	$W_x=W_y$ cm ³	$i_x=i_y$ cm		I_z cm ⁴	W_z cm ³	i_z cm	I_v cm ⁴	W_v cm ³	i_v cm
LF 20 . 1.5	0.219	0.153	0.625	0.138	0.357	0.252	0.797	0.0819	0.115	0.382
LF 20 . 2.0	0.279	0.199	0.618	0.179	0.458	0.324	0.792	0.0995	0.140	0.369
LF 20 . 3.0	0.384	0.282	0.604	0.251	0.635	0.449	0.777	0.133	0.184	0.355
LF 25 . 1.5	0.440	0.244	0.786	0.273	0.714	0.404	1.00	0.167	0.187	0.484
LF 25 . 2.0	0.565	0.317	0.779	0.358	0.923	0.522	0.996	0.207	0.233	0.472
LF 25 . 2.5	0.684	0.389	0.772	0.434	1.12	0.633	0.987	0.250	0.279	0.467
LF 25 . 3.0	0.792	0.456	0.765	0.509	1.30	0.736	0.981	0.283	0.315	0.458
LF 30 . 1.5	0.774	0.355	0.947	0.478	1.25	0.590	1.20	0.296	0.277	0.586
LF 30 . 2.0	1.00	0.464	0.941	0.627	1.63	0.767	1.20	0.373	0.349	0.574
LF 30 . 2.5	1.22	0.570	0.934	0.765	1.98	0.935	1.19	0.452	0.421	0.569
LF 30 . 3.0	1.42	0.672	0.927	0.901	2.32	1.09	1.18	0.518	0.481	0.560
LF 30 . 4.0	1.75	0.855	0.912	1.18	2.93	1.38	1.18	0.574	0.544	0.523
LF 40 . 2.0*	2.44	0.841	1.26	1.51	3.96	1.40	1.61	0.928	0.653	0.779
LF 40 . 3.0*	3.52	1.23	1.25	2.20	5.71	2.02	1.59	1.32	0.920	0.765
LF 40 . 4.0*	4.43	1.58	1.24	2.89	7.32	2.59	1.59	1.55	1.09	0.730
LF 50 . 2.0*	4.85	1.33	1.59	3.00	7.85	2.22	2.02	1.85	1.04	0.980
LF 50 . 3.0*	6.97	1.94	1.57	4.44	11.4	3.23	2.01	2.52	1.44	0.947
LF 50 . 4.0*	8.92	2.52	1.56	5.82	14.7	4.17	2.00	3.09	1.77	0.919
LF 60 . 3.0*	12.3	2.83	1.90	7.74	20.0	4.72	2.42	4.54	2.15	1.15
LF 60 . 4.0*	15.8	3.69	1.88	10.2	26.0	6.13	2.41	5.66	2.69	1.12

LF 60 . 5.0*	39.1	4.52	1.87	12.5	31.7	7.46	2.40	6.59	3.14	1.10
LF 80 . 4.0*	38.8	6.70	2.53	24.5	63.3	11.2	3.23	14.3	5.09	1.54
LF 80 . 5.0*	47.3	8.25	2.52	30.3	77.6	13.7	3.22	17.1	6.07	1.51
LF 80 . 6.0*	55.4	9.74	2.50	35.9	91.3	16.1	3.21	19.4	6.94	1.48
LF 100 . 5.0*	95.1	13.1	3.16	59.4	155	21.9	4.03	35.7	10.1	1.94
LF 100 . 6.0*	112	15.5	3.15	70.7	183	25.8	4.02	41.2	11.7	1.91
LF 100 . 7.0*	128	17.9	3.13	81.8	210	29.7	4.01	46.2	13.1	1.88
LF 120 . 5.0*	167	19.1	3.81	104	270	31.9	4.84	63.4	14.9	2.34
LF 120 . 6.0*	197	22.7	3.79	123	320	37.8	4.84	73.8	17.4	2.32
LF 120 . 7.0*	226	26.2	3.78	143	369	43.5	4.83	83.4	19.7	2.29

Tabla 5 - 3 Perfiles abiertos normalizados - Perfil L de alas desiguales - Medidas

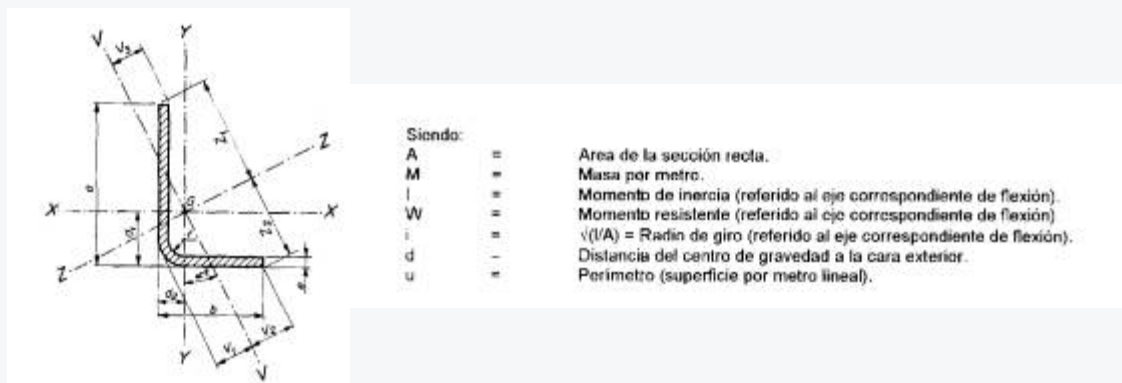

PERFIL	Dimensiones				A cm ²	M kg/m	u m ² /m	Distancia de los ejes							tag A°
	a	b	e	r				d ₁	d ₂	V ₁	V ₂	V ₃	Z ₁	Z ₂	
	mm	mm	mm	mm				cm	cm	cm	cm	cm	cm	cm	
LF 30 . 20 . 1.5	30	20	1.5	1.6	0.712	0.559	0.0980	0.976	4.56	7.32	4.56	0.31	1.53	0.464	
LF 30 . 20 . 2.0	30	20	2.0	2.5	0.930	0.730	0.0970	1.010	4.90	7.22	5.03	0.11	1.55	0.468	
LF 30 . 20 . 3.0	30	20	3.0	3.0	1.35	1.06	0.0961	1.050	5.32	7.00	5.16	0.99	1.53	0.468	
LF 40 . 20 . 2.0*	40	20	2.0	2.5	1.13	0.887	0.117	1.450	4.20	6.97	4.91	1.57	1.83	0.287	
LF 40 . 20 . 3.0*	40	20	3.0	3.0	1.65	1.30	0.116	1.500	4.52	7.14	5.31	1.53	1.86	0.286	
LF 50 . 25 . 2.0*	50	25	2.0	2.5	1.43	1.12	0.147	1.730	5.04	8.67	4.90	2.22	2.26	0.286	
LF 50 . 25 . 3.0*	50	25	3.0	3.0	2.10	1.65	0.146	1.830	5.45	8.84	5.63	2.22	2.30	0.285	
LF 60 . 30 . 3.0*	60	30	3.0	3.0	2.55	2.00	0.176	2.150	6.28	10.51	7.03	3.82	2.73	0.284	
LF 60 . 30 . 4.0*	60	30	4.0	6.0	3.30	2.59	0.173	2.240	6.79	11.41	7.66	4.82	2.80	0.292	

LF 60 . 40 . 3.0	60	40	3.0	3.0	2.85	2.24	0.196	1.950.931.472.091.134.073.06	0.463
LF 60 . 40 . 4.0	60	40	4.0	6.0	3.70	2.91	0.193	2.020.934.422.041.174.023.12	0.472
LF 70 . 40 . 3.0	70	40	3.0	3.0	3.15	2.47	0.216	2.330.856.442.271.024.643.30	0.354
LF 70 . 40 . 4.0	70	40	4.0	6.0	4.10	3.22	0.213	2.460.908.412.211.074.583.36	0.361
LF 70 . 50 . 5.0	70	50	5.0	8.0	5.52	4.34	0.231	2.321.231.732.421.524.733.80	0.535
LF 80 . 40 . 4.0*	80	40	4.0	6.0	4.50	3.53	0.233	2.910.845.332.340.933.133.67	0.289
LF 80 . 40 . 5.0*	80	40	5.0	8.0	5.52	4.34	0.231	2.970.833.332.291.045.073.73	0.293
LF 90 . 60 . 5.0	90	60	5.0	8.0	7.02	5.51	0.291	2.931.432.133.031.726.064.64	0.471
LF 100 . 50 . 5.0*	100	50	5.0	8.0	7.02	5.51	0.291	3.641.051.722.911.246.404.59	0.290
LF 100 . 50 . 6.0*	100	50	6.0	10.0	8.30	6.52	0.289	3.711.111.722.831.236.354.65	0.293
LF 120 . 60 . 5.0*	120	60	5.0	8.0	8.52	6.69	0.351	4.301.222.063.531.447.735.46	0.289
LF 120 . 60 . 6.0*	120	60	6.0	10.0	10.1	7.93	0.349	4.371.272.063.491.497.635.52	0.291
LF 140 . 60 . 6.0	140	60	6.0	10.0	11.3	8.87	0.389	5.231.171.933.631.378.736.22	0.226
LF 150 . 80 . 6.0	150	80	6.0	10.0	13.1	10.3	0.449	5.251.652.734.611.979.736.94	0.321
LF 200 . 100 . 6.0	200	100	6.0	10.0	17.3	13.6	0.589	7.031.943.425.932.3013.08.98	0.287

(*) Perfil utilizable en edificación.

Tabla 5 - 4 Perfiles abiertos normalizados - Perfil L de alas desiguales - Momentos

PERFIL	Referido al eje X-X			Referido al eje Y-Y			I_{xy} cm ⁴	Referido al eje Z-Z			Referido al eje V-V		
	I_x	W_x	i_x	I_y	W_y	i_y		I_z	W_z	i_z	I_v	W_v	i_v
	cm ⁴	cm ³	cm	cm ⁴	cm ³	cm		cm ⁴	cm ³	cm	cm ⁴	cm ³	cm
LF 30 . 20 . 1.5	0.673	0.333	0.972	0.249	0.162	0.591	0.251	0.789	0.388	1.05	0.132	0.127	0.431
LF 30 . 20 . 2.0	0.864	0.433	0.964	0.318	0.211	0.585	0.328	1.02	0.505	1.05	0.165	0.160	0.421
LF 30 . 20 . 3.0	1.22	0.625	0.948	0.442	0.301	0.572	0.464	1.43	0.721	1.03	0.225	0.223	0.408
LF 40 . 20 . 2.0*	1.90	0.746	1.30	0.344	0.218	0.552	0.487	2.04	0.796	1.34	0.204	0.174	0.425
LF 40 . 20 . 3.0*	2.71	1.08	1.28	0.480	0.312	0.539	0.693	2.91	1.15	1.33	0.282	0.246	0.413
LF 50 . 25 . 2.0*	3.81	1.18	1.63	0.692	0.347	0.696	0.969	4.09	1.26	1.69	0.415	0.279	0.539

LF 50 . 25 . 3.0*	5.48	1.73	1.62	0.980	0.501	0.683	1.39	5.88	1.84	1.67	0.583	0.399	0.527
LF 60 . 30 . 3.0*	9.69	2.52	1.95	1.74	0.735	0.827	2.46	10.4	2.69	2.02	1.05	0.590	0.640
LF 60 . 30 . 4.0*	12.3	3.26	1.93	2.20	0.948	0.816	3.22	13.2	3.48	2.00	1.26	0.736	0.617
LF 60 . 40 . 3.0	10.8	2.66	1.94	3.98	1.30	1.18	4.01	12.6	3.11	2.10	2.13	1.02	0.864
LF 60 . 40 . 4.0	13.8	3.46	1.93	5.07	1.68	1.17	5.27	16.2	4.04	2.09	2.58	1.27	0.835
LF 70 . 40 . 3.0	16.4	3.56	2.28	4.15	1.32	1.15	4.97	18.2	3.92	2.40	2.39	1.05	0.871
LF 70 . 40 . 4.0	21.0	4.63	2.26	5.30	1.71	1.14	6.54	23.4	5.11	2.39	2.93	1.33	0.846
LF 70 . 50 . 5.0	27.7	5.91	2.24	12.1	3.25	1.48	11.7	33.9	7.18	2.48	5.85	2.41	1.03
LF 80 . 40 . 4.0*	30.3	5.95	2.60	5.49	1.74	1.10	7.84	32.6	6.36	2.69	3.22	1.38	0.846
LF 80 . 40 . 5.0*	36.6	7.29	2.58	6.59	2.12	1.09	9.62	39.4	7.77	2.67	3.77	1.65	0.826
LF 90 . 60 . 5.0	59.4	9.86	2.91	22.0	4.81	1.77	22.6	70.0	11.6	3.16	11.3	3.68	1.27
LF 100 . 50 . 5.0*	73.9	11.6	3.24	13.4	3.40	1.38	19.2	79.5	12.4	3.36	7.81	2.68	1.06
LF 100 . 50 . 6.0*	86.2	13.7	3.22	15.6	4.00	1.37	22.7	92.9	14.6	3.34	8.90	3.11	1.04
LF 120 . 60 . 5.0*	130	16.9	3.91	23.7	4.97	1.67	33.6	140	18.1	4.05	14.0	3.97	1.28
LF 120 . 60 . 6.0*	153	20.1	3.89	27.7	5.86	1.66	39.8	165	21.4	4.04	16.1	4.63	1.26
LF 140 . 60 . 6.0	233	26.8	4.54	28.8	5.96	1.60	48.8	244	27.9	4.65	17.7	4.82	1.25
LF 150 . 80 . 6.0	314	32.2	4.90	67.3	10.6	2.27	88.3	342	35.0	5.11	38.9	8.44	1.72
LF 200 . 100 . 6.0	745	57.5	6.56	137	16.9	2.81	190	800	61.5	6.80	82.0	13.7	2.18

(*) Perfil utilizable en edificación.

5.1.2. PERFILES ABIERTOS CONFORMADOS EN FRÍO. PERFIL UF. UNE 36-572-80.



Tabla 5 5 Perfiles abiertos normalizados - Perfil U - Medidas

PERFIL	Dimensiones				A cm ²	M kg/m	u m ² /m	d cm	x _M cm
	h	b	e	r					
	mm	mm	mm	mm					
UF 25 x 25 x 1.5	25	25	1.5	1.6	1.05	0.823	0.143	0.917	1.91
UF 30 x 30 x 1.5	30	30	1.5	1.6	1.27	1.00	0.173	1.08	2.29
UF 30 x 30 x 2.0	30	30	2.0	2.5	1.66	1.30	0.170	1.12	2.29
UF 30 x 30 x 3.0	30	30	3.0	3.0	2.40	1.88	0.166	1.17	2.27
UF 20 x 40 x 2.0	40	20	2.0	2.5	1.46	1.14	0.150	0.597	1.24
UF 20 x 40 x 3.0	40	20	3.0	3.0	2.10	1.65	0.146	0.641	1.22
UF 20 x 40 x 4.0	40	20	4.0	6.0	2.60	2.04	0.138	0.710	1.20
UF 30 x 40 x 2.0	40	30	2.0	2.5	1.86	1.46	0.190	1.01	2.13
UF 30 x 40 x 3.0	40	30	3.0	3.0	2.70	2.12	0.186	1.05	2.11
UF 30 x 40 x 4.0	40	30	4.0	6.0	3.40	2.67	0.178	1.13	2.11
UF 40 x 40 x 2.0	40	40	2.0	2.5	2.26	1.77	0.230	1.45	3.06
UF 40 x 40 x 3.0	40	40	3.0	3.0	3.30	2.59	0.226	1.50	3.05
UF 40 x 40 x 4.0	40	40	4.0	6.0	4.20	2.30	0.218	1.58	3.05
UF 30 x 50 x 2.0	50	30	2.0	2.5	2.06	1.62	0.210	0.918	1.99
UF 30 x 50 x 3.0	50	30	3.0	3.0	3.00	2.36	0.206	0.964	1.97
UF 30 x 50 x 4.0	50	30	4.0	6.0	3.80	2.98	0.198	1.03	1.97
UF 40 x 50 x 2.0	50	40	2.0	2.5	2.46	1.93	0.250	1.34	2.90
UF 40 x 50 x 3.0	50	40	3.0	3.0	3.60	2.83	0.246	1.39	2.88
UF 40 x 50 x 4.0	50	40	4.0	6.0	4.60	3.61	0.238	1.46	2.89

(*) Perfil utilizable en edificación.

Tabla 5.5. Perfiles abiertos normalizados - Perfil U - Medidas

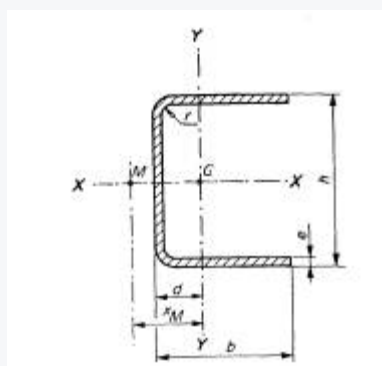
PERFIL	Dimensiones				A cm ²	M kg/m	u m ² /m	d cm	x _M cm
	h	b	e	r					

	mm	mm	mm	mm					
UF 50 x 50 x 2.0	50	50	2.0	2.5	2.86	2.24	0.290	1.78	3.83
UF 50 x 50 x 3.0	50	50	3.0	3.0	4.20	3.30	0.286	1.83	3.81
UF 50 x 50 x 4.0	50	50	4.0	6.0	5.40	4.24	0.278	1.91	3.83
UF 30 x 60 x 2.0*	60	30	2.0	2.5	2.26	1.77	0.230	0.846	1.87
UF 30 x 60 x 3.0*	60	30	3.0	3.0	3.30	2.59	0.226	0.890	1.85
UF 30 x 60 x 4.0*	60	30	4.0	6.0	4.20	3.30	0.218	0.954	1.85
UF 40 x 60 x 2.0	60	40	2.0	2.5	2.66	2.09	0.270	1.24	2.75
UF 40 x 60 x 3.0	60	40	3.0	3.0	3.90	2.06	0.266	1.29	2.73
UF 40 x 60 x 4.0	60	40	4.0	6.0	5.00	3.92	0.258	1.36	2.74
UF 50 x 60 x 2.0	60	50	2.0	2.5	3.06	2.40	0.310	1.67	3.66
UF 50 x 60 x 3.0	60	50	3.0	3.0	4.50	3.53	0.306	1.72	3.64
UF 50 x 60 x 4.0	60	50	4.0	6.0	5.80	4.55	0.298	1.79	3.66
UF 40 x 70 x 2.0	70	40	2.0	2.5	2.86	2.24	0.290	1.16	2.61
UF 40 x 70 x 3.0	70	40	3.0	3.0	4.20	3.30	0.286	1.21	2.60
UF 40 x 70 x 4.0	70	40	4.0	6.0	5.40	4.24	0.278	1.28	2.61
UF 50 x 70 x 2.0	70	50	2.0	2.5	3.26	2.56	0.330	1.57	3.51
UF 50 x 70 x 3.0	70	50	3.0	3.0	4.80	3.77	0.326	1.62	3.49
UF 50 x 70 x 4.0	70	50	4.0	6.0	6.20	4.87	0.318	1.69	3.51
UF 40 x 80 x 3.0*	80	40	3.0	3.0	4.50	3.53	0.306	1.14	2.48
UF 40 x 80 x 4.0*	80	40	4.0	6.0	5.80	4.55	0.298	1.20	2.49
UF 40 x 80 x 5.0*	80	40	5.0	8.0	7.04	5.52	0.292	1.26	2.48
UF 60 x 80 x 3.0	80	60	3.0	3.0	5.70	4.48	0.386	1.95	4.25
UF 60 x 80 x 4.0	80	60	4.0	6.0	7.40	5.81	0.378	2.02	4.28
UF 60 x 80 x 5.0	80	60	5.0	8.0	9.04	7.10	0.372	2.09	4.28

UF 45 x 90 x 3.0	90	45	3.0	3.0	5.10	4.00	0.346	1.26	2.79
UF 45 x 90 x 4.0	90	45	4.0	6.0	6.60	5.18	0.338	1.32	2.81
UF 45 x 90 x 5.0	90	45	5.0	8.0	8.04	6.31	0.332	1.38	2.80
UF 50 x 100 x 3.0*	100	50	3.0	3.0	5.70	4.48	0.386	1.39	3.10
UF 50 x 100 x 4.0*	100	50	4.0	6.0	7.40	5.81	0.378	1.45	3.12
UF 50 x 100 x 5.0*	100	50	5.0	8.0	9.04	7.10	0.372	1.50	3.12
UF 50 x 100 x 6.0*	100	50	6.0	10.0	10.6	8.32	0.366	1.56	3.11
UF 60 x 100 x 3.0	100	60	3.0	6.0	6.22	4.88	0.421	1.80	4.02
UF 60 x 100 x 4.0	100	60	4.0	8.0	8.13	6.38	0.415	1.86	4.02
UF 60 x 100 x 5.0	100	60	5.0	10.0	9.95	7.81	0.409	1.92	4.02
UF 60 x 120 x 4.0*	120	60	4.0	6.0	9.00	7.06	0.458	1.70	3.75
UF 60 x 120 x 5.0*	120	60	5.0	8.0	11.0	8.66	0.452	1.75	3.75
UF 60 x 120 x 6.0*	120	60	6.0	10.0	13.0	10.2	0.446	1.81	3.75
UF 70 x 140 x 4.0*	140	70	4.0	6.0	10.6	8.32	0.538	1.95	4.38
UF 70 x 140 x 5.0*	140	70	5.0	8.0	13.0	10.2	0.532	2.00	4.38
UF 70 x 140 x 6.0*	140	70	6.0	10.0	15.4	12.1	0.526	2.06	4.38
UF 80 x 160 x 7.0	160	80	7.0	12.0	20.5	16.1	0.599	2.36	5.01
UF 80 x 160 x 8.0	160	80	8.0	16.0	22.9	18.0	0.590	2.44	5.02
UF 90 x 180 x 7.0	180	90	7.0	12.0	23.3	18.3	0.679	2.61	5.64
UF 90 x 180 x 8.0	180	90	8.0	16.0	26.1	20.5	0.670	2.68	5.66
UF 100 x 200 x 6.0	200	100	6.0	10.0	22.6	17.7	0.766	2.80	6.27
UF 100 x 200 x 7.0	200	100	7.0	12.0	26.1	20.5	0.759	2.86	6.27
UF 100 x 200 x 8.0	200	100	8.0	16.0	29.3	23.0	0.750	2.93	6.29
UF 100 x 220 x 6.0	220	100	6.0	10.0	23.8	18.7	0.806	2.68	6.05
UF 100 x 220 x 7.0	220	100	7.0	12.0	27.5	21.6	0.799	2.73	6.05
UF 100 x 220 x 8.0	220	100	8.0	16.0	30.9	24.3	0.790	2.80	6.07

UF 100 x 250 x 6.0	250	100	6.0	10.0	25.6	20.1	0.866	2.51	5.75
UF 100 x 250 x 7.0	250	100	7.0	12.0	29.6	23.2	0.859	2.56	5.74
UF 100 x 250 x 8.0	250	100	8.0	16.0	33.3	26.2	0.850	2.63	5.77
UF 100 x 300 x 7.0	300	100	7.0	12.0	33.1	26.0	0.959	2.33	5.31
UF 100 x 300 x 8.0	300	100	8.0	16.0	37.3	29.3	0.950	2.39	5.32
(*) Perfil utilizable en edificación.									

Siendo:

A = Área de la sección recta.

M = Masa por metro.

I = Momento de inercia (referido al eje correspondiente de flexión).

W = Momento resistente (referido al eje correspondiente de flexión).

i = $\sqrt{I/A}$ = Radio de giro (referido al eje correspondiente de flexión).

d = Distancia del centro de gravedad a la cara exterior.

x_M = Distancia del centro de presión M al eje Y-Y.

I_T = Módulo de torsión.

I_A = Módulo de alabeo.

u = Perímetro (superficie por metro lineal).

Tabla 5 6 Perfiles abiertos normalizados - Perfil U - Momentos

PERFIL	Referido al eje X - X			Referido al eje Y - Y			I_T cm ⁴	I_A cm ⁶
	I_x cm ⁴	W_x cm ³	i_x cm	I_y cm ⁴	W_y cm ³	i_y cm ³		
UF 25 x 25 x 1.5	1.12	0.899	1.03	0.684	0.432	0.807	0.00787	0.637
UF 30 x 30 x 1.5	2.01	1.34	1.26	1.21	0.631	0.974	0.00956	1.68
UF 30 x 30 x 2.0	2.52	1.68	1.23	1.54	0.819	0.965	0.0221	2.00
UF 30 x 30 x 3.0	3.39	2.26	1.19	2.15	1.18	0.947	0.0721	2.50
UF 20 x 40 x 2.0	3.43	1.72	1.53	0.558	0.397	0.618	0.0195	1.27
UF 20 x 40 x 3.0	4.65	2.32	1.49	0.769	0.566	0.605	0.0631	1.57
UF 20 x 40 x 4.0	5.24	2.62	1.42	0.912	0.707	0.592	0.139	1.36
UF 30 x 40 x 2.0	4.87	2.44	1.62	1.73	0.867	0.964	0.0248	4.09

UF 30 x 40 x 3.0	6.71	3.35	1.58	2.43	1.25	0.949	0.0811	5.27
UF 30 x 40 x 4.0	7.84	3.92	1.52	2.94	1.57	0.930	0.182	5.20
UF 40 x 40 x 2.0	6.32	3.16	1.67	3.81	1.49	1.30	0.0301	9.33
UF 40 x 40 x 3.0	8.77	4.38	1.63	5.42	2.17	1.28	0.0991	12.3
UF 40 x 40 x 4.0	10.4	5.22	1.58	6.64	2.75	1.26	0.224	12.9
UF 30 x 50 x 2.0	8.16	3.6	1.99	1.88	0.902	0.955	0.0275	7.10
UF 30 x 50 x 3.0	11.4	4.55	1.95	2.66	1.30	0.941	0.0901	9.33
UF 30 x 50 x 4.0	13.5	5.41	1.89	3.25	1.66	0.926	0.203	9.62
UF 40 x 50 x 2.0	10.5	4.19	2.06	4.14	1.56	1.30	0.0328	16.0
UF 40 x 50 x 3.0	14.7	5.88	2.02	5.92	2.27	1.28	0.108	21.5
UF 40 x 50 x 4.0	17.8	7.10	1.97	7.34	2.89	1.26	0.246	23.3
UF 50 x 50 x 2.0	12.8	5.11	2.11	7.62	2.36	1.63	0.0381	30.1
UF 50 x 50 x 3.0	18.0	7.20	2.07	11.0	3.46	1.62	0.126	41.0
UF 50 x 50 x 4.0	22.0	8.80	2.02	13.7	4.44	1.59	0.288	45.9
UF 30 x 60 x 2.0*	12.5	4.16	2.35	2.00	0.928	0.941	0.0301	11.1
UF 30 x 60 x 3.0*	17.5	5.85	2.31	2.84	1.34	0.927	0.0991	14.8
UF 30 x 60 x 4.0*	21.1	7.03	2.24	3.51	1.72	0.914	0.224	15.8
UF 40 x 60 x 2.0	15.8	5.28	2.44	4.43	1.61	1.29	0.0355	24.9
UF 40 x 60 x 3.0	22.4	7.47	2.40	6.35	2.34	1.28	0.117	33.8
UF 40 x 60 x 4.0	27.4	9.12	2.34	7.93	3.01	1.26	0.267	37.6
UF 50 x 60 x 2.0	19.2	6.40	2.51	8.14	2.45	1.63	0.0408	46.6
UF 50 x 60 x 3.0	27.3	9.10	2.46	11.8	3.58	1.62	0.135	64.0
UF 50 x 60 x 4.0	33.6	11.2	2.41	14.8	4.62	1.60	0.310	73.0
UF 40 x 70 x 2.0	22.6	6.44	2.81	4.67	1.65	1.28	0.0381	36.2
UF 40 x 70 x 3.0	32.1	9.19	2.76	6.71	2.41	1.26	0.126	49.6

UF 40 x 70 x 4.0	39.5	11.3	2.70	8.44	3.10	1.25	0.288	56.1
UF 50 x 70 x 2.0	27.2	7.76	2.89	8.61	2.51	1.62	0.0435	67.4
UF 50 x 70 x 3.0	38.8	11.1	2.84	12.4	3.68	1.61	0.144	93.3
UF 50 x 70 x 4.0	48.2	13.8	2.79	15.8	4.76	1.59	0.331	108
UF 40 x 80 x 3.0*	43.9	11.0	3.12	7.03	2.46	1.25	0.135	69.0
UF 40 x 80 x 4.0*	54.3	13.6	3.06	8.88	3.17	1.24	0.310	79.3
UF 40 x 80 x 5.0*	63.4	15.9	3.00	10.5	3.84	1.22	0.587	85.7
UF 60 x 80 x 3.0	61.7	15.4	3.29	21.6	5.32	1.94	0.171	216
UF 60 x 80 x 4.0	77.4	19.4	3.23	27.5	6.92	1.93	0.395	257
UF 60 x 80 x 5.0	91.6	22.9	3.18	33.0	8.44	1.91	0.754	288
UF 45 x 90 x 3.0	63.6	14.1	3.53	10.2	3.14	1.41	0.153	128
UF 45 x 90 x 4.0	79.4	17.6	3.47	12.9	4.06	1.40	0.352	151
UF 45 x 90 x 5.0	93.6	20.8	3.41	15.4	4.95	1.38	0.671	167
UF 50 x 100 x 3.0*	88.4	17.7	3.94	14.1	3.90	1.57	0.171	223
UF 50 x 100 x 4.0*	111	22.3	3.88	18.0	5.07	1.56	0.395	266
UF 50 x 100 x 5.0*	132	26.4	3.82	21.6	6.19	1.55	0.754	299
UF 50 x 100 x 6.0*	150	30.0	3.76	24.9	7.24	1.53	1.27	319
UF 60 x 100 x 3.0	101	20.1	4.02	23.1	5.50	1.92	0.187	355
UF 60 x 100 x 4.0	128	25.6	3.97	29.7	7.17	1.91	0.434	432
UF 60 x 100 x 5.0	152	30.5	3.91	35.7	8.76	1.90	0.830	489
UF 60 x 120 x 4.0*	198	33.1	4.70	31.9	7.42	1.88	0.480	702
UF 60 x 120 x 5.0*	238	39.6	4.64	38.6	9.08	1.87	0.921	808
UF 60 x 120 x 6.0*	273	45.5	4.58	44.8	10.7	1.86	1.56	886
UF 70 x 140 x 4.0*	322	46.0	5.51	51.6	10.2	2.21	0.566	1580
UF 70 x 140 x 5.0*	388	55.5	5.46	62.7	12.5	2.19	1.09	1850

UF 70 x 140 x 6.0*	449	64.2	5.40	73.1	14.8	2.18	1.85	2060
UF 80 x 160 x 7.0	777	97.2	6.16	127	22.5	2.49	3.35	4620
UF 80 x 160 x 8.0	850	106	6.09	140	25.2	2.48	4.90	4780
UF 90 x 180 x 7.0	1130	126	6.98	184	28.8	2.81	3.80	8740
UF 90 x 180 x 8.0	1250	139	6.91	204	32.4	2.80	5.58	9190
UF 100 x 200 x 6.0	1390	139	7.85	224	31.1	3.15	2.71	13800
UF 100 x 200 x 7.0	1590	159	7.80	256	35.9	3.13	4.26	15400
UF 100 x 200 x 8.0	1750	175	7.73	286	40.4	3.12	6.26	16400
UF 100 x 220 x 6.0	1740	158	8.56	231	31.6	3.12	2.86	17500
UF 100 x 220 x 7.0	1980	180	8.50	264	36.4	3.10	4.49	19500
UF 100 x 220 x 8.0	2200	200	8.43	295	41.0	3.09	6.60	20800
UF 100 x 250 x 6.0	2350	188	9.59	241	32.1	3.07	3.07	23900
UF 100 x 250 x 7.0	2690	215	9.53	276	37.1	3.05	4.83	26800
UF 100 x 250 x 8.0	2980	238	9.46	308	41.8	3.04	7.11	28800
UF 100 x 300 x 7.0	4160	277	11.2	291	37.9	2.97	5.40	42000
UF 100 x 300 x 8.0	4620	308	11.1	326	42.9	2.96	7.97	45500

(*) Perfil utilizable en edificación.

5.1.3. PERFILES ABIERTOS CONFORMADOS EN FRÍO. PERFIL CF. UNE 36-573-79

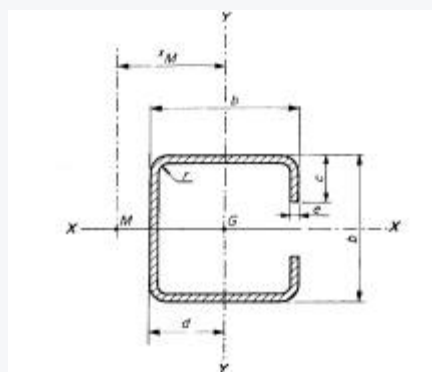

Perfil C cuadrado conformado en frío

Tabla 5 - 7 Perfiles abiertos normalizados - Perfil C cuadrado - Medidas

PERFIL	Dimensiones				A cm ²	M kg/m	u m ² /m	d cm	x _M cm
	b	c	e	r					

	mm	mm	mm	mm					
CF 20 x 1.5	20	8	1.5	1.6	0.988	0.776	0.135	0.944	1.91
CF 25 x 1.5	25	10	1.5	1.6	1.27	0.999	0.173	1.18	2.57
CF 25 x 2.0	25	10	2.0	2.5	1.62	1.27	0.166	1.18	2.23
CF 30 x 1.5	30	10	1.5	1.6	1.50	1.18	0.203	1.36	2.98
CF 30 x 2.0	30	10	2.0	2.5	1.92	1.50	0.196	1.35	2.68
CF 40 x 1.5	40	15	1.5	1.6	2.10	1.65	0.283	1.86	4.42
CF 40 x 2.0	40	15	2.0	2.5	2.72	2.13	0.276	1.86	4.11
CF 50 x 2.0	50	20	2.0	2.5	3.52	2.76	0.356	2.36	5.56
CF 50 x 3.0	50	20	3.0	3.0	5.10	4.00	0.347	2.36	5.19
CF 65 x 4.0	65	25	4.0	6.0	8.60	6.75	0.439	3.04	6.13

Tabla 5 8 Perfiles abiertos normalizados – Perfil C cuadrado - Momentos

PERFIL	Referido al eje X - X			Referido al eje Y - Y			I_T cm^4	I_A cm^6
	I_x	W_x	i_x	I_y	W_y	i_y		
	cm^4	cm^3	cm	cm^4	cm^3	cm^3		
CF 20 x 1.5	0.578	0.578	0.765	0.524	0.496	0.728	0.00742	1.12
CF 25 x 1.5	1.21	0.967	0.974	1.10	0.834	0.930	0.00956	3.44
CF 25 x 2.0	1.45	1.16	0.947	1.31	0.993	0.901	0.0216	4.76
CF 30 x 1.5	2.17	1.45	1.20	1.85	1.13	1.11	0.0112	6.63
CF 30 x 2.0	2.66	1.77	1.18	2.24	1.36	1.08	0.0256	9.16
CF 40 x 1.5	5.46	2.73	1.61	4.88	2.28	1.52	0.0158	32.8
CF 40 x 2.0	6.84	3.42	1.59	6.08	2.84	1.50	0.0363	45.2
CF 50 x 2.0	14.0	5.60	2.00	12.8	4.86	1.91	0.0469	151
CF 50 x 3.0	19.4	7.76	1.95	17.7	6.70	1.86	0.153	217
CF 65 x 4.0	54.9	16.9	2.53	49.0	14.2	2.39	0.459	1120

Siendo:

A = Área de la sección recta.

- M = Masa por metro.
- I = Momento de inercia (referido al eje correspondiente de flexión).
- W = Momento resistente (referido al eje correspondiente de flexión).
- i = $\sqrt{I/A}$ = Radio de giro (referido al eje correspondiente de flexión).
- d = Distancia del centro de gravedad a la cara exterior.
- x_M = Distancia del centro de presión M al eje Y-Y.
- I_T = Módulo de torsión.
- I_A = Módulo de alabeo.
- u = Perímetro (superficie por metro lineal).

Perfil C rectangular conformado en frío



Tabla 5 9 Perfiles abiertos normalizados – Perfil C rectangular - Medidas

PERFIL	Dimensiones					A cm ²	M kg/m	u m ² /m	d cm	x_M cm	
	h mm	b mm	c mm	e mm	r mm						
CF 60 x 2.0	60	40	15	2.0	2.5	3.12	2.45	0.316	1.63	3.72	
CF 60 x 2.5	60	40	15	2.5	2.5	3.84	3.01	0.312	1.63	3.62	
CF 60 x 3.0	60	40	15	3.0	3.0	4.50	3.53	0.307	1.63	3.45	
CF 80 x 2.0	80	40	15	2.0	2.5	3.52	2.76	0.356	1.46	3.40	
CF 80 x 2.5	80	40	15	2.5	2.5	4.34	3.40	0.352	1.46	3.31	
CF 80 x 3.0	80	40	15	3.0	3.0	5.10	4.00	0.347	1.46	3.17	
CF 100 x 2.0	100	40	15	2.0	2.5	3.92	3.08	0.396	1.32	3.14	
CF 100 x 2.5	100	40	15	2.5	2.5	4.84	3.80	0.392	1.32	3.06	
CF 100 x 3.0	100	40	15	3.0	3.0	5.70	4.48	0.387	1.32	2.94	
CF 120 x 2.0	120	50	20	2.0	2.5	4.92	3.86	0.496	1.72	4.22	
CF 120 x 2.5	120	50	20	2.5	2.5	6.08	4.78	0.492	1.72	4.14	
CF 120 x 3.0	120	50	20	3.0	3.0	7.20	5.65	0.487	1.72	4.02	

CF 140 x 2.0	140	50	20	2.0	2.5	5.32	4.17	0.536	1.60	3.97		
CF 140 x 2.5	140	50	20	2.5	2.5	6.58	5.17	0.532	1.60	3.89		
CF 140 x 3.0	140	50	20	3.0	3.0	7.80	6.12	0.527	1.60	3.78		
CF 160 x 2.0	160	60	20	2.0	2.5	6.12	4.80	0.616	1.86	4.62		
CF 160 x 2.5	160	60	20	2.5	2.5	7.58	5.95	0.612	1.86	4.54		
CF 160 x 3.0	160	60	20	3.0	3.0	9.00	7.07	0.607	1.86	4.43		
CF 180 x 2.0	180	60	20	2.0	2.5	6.52	5.12	0.656	1.75	4.40		
CF 180 x 2.5	180	60	20	2.5	2.5	8.08	6.35	0.652	1.76	4.33		
CF 180 x 3.0	180	60	20	3.0	3.0	9.60	7.54	0.647	1.75	4.22		
CF 200 x 2.0	200	60	20	2.0	2.5	6.92	5.43	0.696	1.66	4.20		
CF 200 x 2.5	200	60	20	2.5	2.5	8.58	6.74	0.692	1.66	4.13		
CF 200 x 3.0	200	60	20	3.0	3.0	10.2	8.01	0.687	1.66	4.04		
CF 225 x 2.5	225	80	25	2.5	2.5	10.5	8.21	0.842	2.38	5.96		
CF 225 x 3.0	225	80	25	3.0	3.0	12.5	9.78	0.837	2.38	5.86		
CF 225 x 4.0	225	80	25	4.0	6.0	16.2	12.7	0.819	2.36	5.53		
CF 250 x 2.5	250	80	25	2.5	2.5	11.1	8.70	0.892	2.25	5.70		
CF 250 x 3.0	250	80	25	3.0	3.0	13.2	10.4	0.887	2.25	5.60		
CF 250 x 4.0	250	80	25	4.0	6.0	17.2	13.5	0.869	2.23	5.30		
CF 275 x 2.5	275	80	25	2.5	2.5	11.7	9.19	0.942	2.14	5.47		
CF 275 x 3.0	275	80	25	3.0	3.0	14.0	11.0	0.937	2.14	5.37		
CF 275 x 4.0	275	80	25	4.0	6.0	18.2	14.3	0.919	2.12	5.09		
CF 300 x 2.5	300	80	25	2.5	2.5	12.3	9.68	0.992	2.04	5.25		
CF 300 x 3.0	300	80	25	3.0	3.0	14.7	11.5	0.987	2.04	5.16		
CF 300 x 4.0	300	80	25	4.0	6.0	19.2	15.1	0.969	2.02	4.89		
Nota: Perfiles utilizables en edificación.												

Tabla 5 10 Perfiles abiertos normalizados – Perfil C rectangular - Momentos

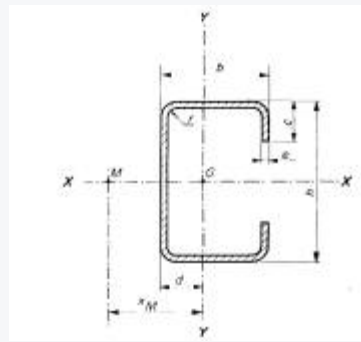
PERFIL	Referido al eje X – X			Referido al eje Y - Y			I _T cm ⁴	I _A cm ⁶
	I _x cm ⁴	W _x cm ³	i _x cm	I _y cm ⁴	W _y cm ³	i _y cm ³		
CF 60 x 2.0	17.8	5.93	2.39	7.16	3.03	1.52	0.0416	74.9
CF 60 x 2.5	21.5	7.16	2.37	8.56	3.62	1.49	0.0800	90.4
CF 60 x 3.0	24.6	8.22	2.34	9.71	4.10	1.47	0.135	109
CF 80 x 2.0	34.9	8.74	3.15	8.00	3.15	1.51	0.0469	122
CF 80 x 2.5	42.4	10.6	3.13	9.57	3.77	1.49	0.0904	148
CF 80 x 3.0	49.0	12.3	3.10	10.9	4.28	1.46	0.153	179
CF 100 x 2.0	59.2	11.8	3.89	8.67	3.24	1.49	0.0523	189
CF 100 x 2.5	72.1	14.4	3.86	10.4	3.87	1.46	0.101	228
CF 100 x 3.0	83.6	16.7	3.83	11.8	4.40	1.44	0.171	275
CF 120 x 2.0	109	18.1	4.70	17.9	5.47	1.91	0.0656	547
CF 120 x 2.5	133	22.2	4.68	21.7	6.61	1.89	0.127	668
CF 120 x 3.0	156	25.9	4.65	25.0	7.60	1.86	0.216	808
CF 140 x 2.0	156	22.3	5.42	18.9	5.56	1.89	0.0709	751
CF 140 x 2.5	192	27.4	5.40	22.9	6.72	1.86	0.137	917
CF 140 x 3.0	225	32.1	5.37	26.3	7.74	1.84	0.234	1100
CF 160 x 2.0	240	30.0	6.26	30.5	7.37	2.23	0.0816	1490
CF 160 x 2.5	295	36.8	6.23	37.0	8.95	2.21	0.158	1830
CF 160 x 3.0	346	43.3	6.20	42.9	10.4	2.18	0.270	2190
CF 180 x 2.0	316	35.1	6.97	31.7	7.46	2.20	0.0869	1930
CF 180 x 2.5	389	43.2	6.94	38.5	9.06	2.18	0.169	2360
CF 180 x 3.0	458	50.9	6.90	44.5	10.5	2.15	0.288	2830
CF 200 x 2.0	406	40.6	7.66	32.7	7.53	2.17	0.0923	2440

CF 200 x 2.5	500	50.0	7.63	39.7	9.15	2.15	0.179	2980
CF 200 x 3.0	588	58.8	7.60	46.0	10.6	2.12	0.306	3560
CF 225 x 2.5	806	71.7	8.78	90.8	16.2	2.95	0.218	8320
CF 225 x 3.0	953	84.7	8.75	106	18.9	2.92	0.374	9980
CF 225 x 4.0	1210	108	8.66	131	23.3	2.85	0.865	14100
CF 250 x 2.5	1030	82.6	9.65	93.8	16.3	2.91	0.231	10500
CF 250 x 3.0	1220	97.7	9.62	110	19.1	2.88	0.396	12600
CF 250 x 4.0	1560	125	9.52	136	23.5	2.81	0.916	17600
CF 275 x 2.5	1290	94.1	10.5	96.5	16.5	2.87	0.244	13100
CF 275 x 3.0	1530	111	10.5	113	19.2	2.84	0.419	15600
CF 275 x 4.0	1960	142	10.4	140	23.8	2.77	0.971	21700
CF 300 x 2.5	1590	106	11.4	98.9	16.6	2.83	0.257	15900
CF 300 x 3.0	1890	126	11.3	116	19.4	2.80	0.441	19000
CF 300 x 4.0	2410	161	11.2	143	24.0	2.73	1.02	26200

Nota: Perfiles utilizables en edificación.

Siendo:

A = Área de la sección recta.

M = Masa por metro.

I = Momento de inercia (referido al eje correspondiente de flexión).

W = Momento resistente (referido al eje correspondiente de flexión).

i = $\sqrt{I/A}$ = Radio de giro (referido al eje correspondiente de flexión).

d = Distancia del centro de gravedad a la cara exterior.

x_M = Distancia del centro de presión M al eje Y-Y.

I_T = Módulo de torsión.

I_A = Módulo de alabeo.

u = Perímetro (superficie por metro lineal).

5.1.4. PERFILES ABIERTOS CONFORMADOS EN FRÍO. PERFIL NF. UNE 36-574-79

OF 25 x 25 x 1.5	25	25	15	1.5	1.6	1.42	1.12	0.190	1.19	1.94		
OF 25 x 25 x 2.0	25	25	15	2.0	2.5	1.82	1.43	0.182	1.19	1.91		
OF 30 x 30 x 1.5	30	30	15	1.5	1.6	1.65	1.29	0.220	1.50	2.47		
OF 30 x 30 x 2.0	30	30	15	2.0	2.5	2.12	1.66	0.212	1.50	2.45		
OF 40 x 25 x 2.0	40	25	15	2.0	2.5	2.42	1.90	0.242	1.92	3.27		
OF 40 x 25 x 3.0	40	25	15	3.0	3.0	3.46	2.71	0.231	1.92	3.20		
OF 40 x 40 x 2.0*	40	40	15	2.0	2.5	2.72	2.13	0.272	2.14	3.46		
OF 40 x 40 x 2.5*	40	40	15	2.5	2.5	3.34	2.62	0.267	2.14	3.42		
OF 40 x 40 x 3.0*	40	40	15	3.0	3.0	3.91	3.07	0.261	2.14	3.39		
OF 50 x 50 x 2.0*	50	50	17	2.0	2.5	3.40	2.67	0.340	2.73	4.38		
OF 50 x 50 x 2.5*	50	50	17	2.5	2.5	4.19	3.29	0.335	2.73	4.34		
OF 50 x 50 x 3.0*	50	50	17	3.0	3.0	4.93	3.87	0.329	2.73	4.31		
OF 60 x 40 x 2.0*	60	40	20	2.0	2.5	3.72	2.92	0.372	3.00	5.19		
OF 60 x 40 x 2.5*	60	40	20	2.5	2.5	4.59	3.60	0.367	3.00	5.15		
OF 60 x 40 x 3.0*	60	40	20	3.0	3.0	5.41	4.25	0.361	3.00	5.12		
OF 80 x 50 x 2.5*	80	50	25	2.5	2.5	6.09	4.78	0.487	4.00	6.95		
OF 80 x 50 x 3.0*	80	50	25	3.0	3.0	7.21	5.66	0.481	4.00	6.92		
OF 100 x 50 x 2.5*	100	50	30	2.5	2.5	7.34	5.76	0.587	4.83	8.48		
OF 100 x 50 x 3.0*	100	50	30	3.0	3.0	8.71	6.84	0.581	4.83	8.45		
(*) Perfil utilizable en edificación.												

Tabla 5 14 Perfiles abiertos normalizados - Perfiles omega - Momentos

PERFIL	Referido al eje X - X			Referido al eje Y - Y			I _T cm ⁴	I _A cm ⁶
	I _x cm ⁴	W _x cm ³	i _x cm	I _y cm ⁴	W _y cm ³	i _y cm ³		
	OF 25 x 25 x 1.5	1.31	1.00	0.958	2.65	1.02		
OF 25 x 25 x 2.0	1.57	1.20	0.930	3.26	1.28	1.34	0.0243	1.47

OF 30 x 30 x 1.5	2.18	1.46	1.15	3.93	1.38	1.54	0.0124	2.57
OF 30 x 30 x 2.0	2.67	1.78	1.12	4.88	1.74	1.52	0.0283	2.94
OF 40 x 25 x 2.0	5.04	2.42	1.44	4.06	1.59	1.29	0.0323	5.43
OF 40 x 25 x 3.0	6.69	3.21	1.39	5.33	2.18	1.24	0.104	6.61
OF 40 x 40 x 2.0*	6.08	2.84	1.50	9.84	2.98	1.90	0.0363	10.5
OF 40 x 40 x 2.5*	7.24	3.38	1.47	11.7	3.61	1.88	0.0696	12.0
OF 40 x 40 x 3.0*	8.7	3.81	1.45	13.3	4.17	1.85	0.117	12.9
OF 50 x 50 x 2.0*	12.0	4.40	1.88	18.9	4.72	2.36	0.0453	33.2
OF 50 x 50 x 2.5*	14.4	5.29	1.86	22.8	5.76	2.33	0.0873	38.8
OF 50 x 50 x 3.0*	16.5	6.04	1.83	26.1	6.70	2.30	0.148	42.7
OF 60 x 40 x 2.0*	18.2	6.08	2.21	15.3	4.01	2.03	0.0496	43.0
OF 60 x 40 x 2.5*	22.0	7.34	2.19	18.3	4.89	2.00	0.0956	50.6
OF 60 x 40 x 3.0*	25.3	8.44	2.16	21.0	5.68	1.97	0.162	56.1
OF 80 x 50 x 2.5*	52.6	13.1	2.94	38.8	8.17	2.52	0.127	198
OF 80 x 50 x 3.0*	61.0	15.3	2.91	45.0	9.57	2.50	0.216	225
OF 100 x 50 x 2.5*	96.9	18.8	3.63	50.7	9.66	2.63	0.153	471
OF 100 x 50 x 3.0*	113	21.9	3.60	59.0	11.3	2.60	0.261	539

(*) Perfil utilizable en edificación.

5.1.6. PERFILES ABIERTOS CONFORMADOS EN FRÍO. PERFIL ZF. UNE 36-576-79



Tabla 5 15 Perfiles abiertos normalizados - Perfil Z - Medidas

PERFIL	Dimensiones							A cm ²	M kg/m	u m ² /m	Distancia de los ejes							tag A°
	h	b ₁	b ₂	c ₁	c ₂	e	r				d ₁	d ₂	V ₁	V ₂	V ₃	V ₄	Z ₁	
	mm	mm	mm	mm	mm	mm	mm				cm	cm	cm	cm	cm	cm		

ZF 100 x 2.0	100	60	53	20	17	2.0	2.5	4.72	3.70	0.476	4.810.178.122.812.552.636.957.13	0.667
ZF 100 x 2.5	100	60	53	20	17	2.5	2.5	5.84	4.58	0.472	4.810.153.122.802.542.626.917.14	0.662
ZF 100 x 3.0	100	60	53	20	17	3.0	3.0	6.91	5.42	0.467	4.810.128.112.772.512.626.857.09	0.657
ZF 120 x 2.0	120	60	53	20	17	2.0	2.5	5.12	4.02	0.516	5.730.153.312.732.532.817.577.85	0.510
ZF 120 x 2.5	120	60	53	20	17	2.5	2.5	6.34	4.98	0.512	5.730.133.312.732.512.817.537.82	0.505
ZF 120 x 3.0	120	60	53	20	17	3.0	3.0	7.51	5.89	0.507	5.730.108.312.752.432.817.477.77	0.501
ZF 140 x 2.0	140	60	53	20	17	2.0	2.5	5.52	4.33	0.556	6.770.138.442.732.452.958.278.61	0.407
ZF 140 x 2.5	140	60	53	20	17	2.5	2.5	6.84	5.37	0.552	6.770.113.442.722.452.958.238.53	0.404
ZF 140 x 3.0	140	60	53	20	17	3.0	3.0	8.11	6.36	0.547	6.770.083.442.632.422.958.138.54	0.400
ZF 160 x 2.0	160	60	53	20	17	2.0	2.5	5.92	4.65	0.596	7.750.123.552.652.333.05904.9.43	0.336
ZF 160 x 2.5	160	60	53	20	17	2.5	2.5	7.34	5.76	0.592	7.750.098.552.642.333.059.09.40	0.333
ZF 160 x 3.0	160	60	53	20	17	3.0	3.0	8.71	6.84	0.587	7.750.073.552.622.333.058.959.35	0.329
ZF 180 x 2.0	180	60	53	20	17	2.0	2.5	6.32	4.96	0.636	8.730.108.642.532.323.149.8510.3	0.284
ZF 180 x 2.5	180	60	53	20	17	2.5	2.5	7.84	6.15	0.632	8.730.083.642.532.313.149.8210.3	0.281
ZF 180 x 3.0	180	60	53	20	17	3.0	3.0	9.31	7.31	0.627	8.730.058.642.542.233.149.7310.2	0.278
ZF 200 x 2.0	200	80	70	25	22	2.0	2.5	7.66	6.01	0.770	9.630.208.653.533.233.9711.512.0	0.366
ZF 200 x 2.5	200	80	70	25	22	2.5	2.5	9.51	7.47	0.766	9.630.174.653.573.223.9711.512.0	0.364
ZF 200 x 3.0	200	80	70	25	22	3.0	3.0	11.3	8.88	0.761	9.630.154.673.543.133.9711.512.0	0.361
ZF 225 x 2.5	225	80	70	25	22	2.5	2.5	10.1	7.96	0.816	10.30.158.733.473.134.0312.513.1	0.307
ZF 225 x 3.0	225	80	70	25	22	3.0	3.0	12.1	9.47	0.811	10.30.133.733.443.134.0312.513.0	0.304
ZF 225 x 4.0	225	80	70	25	22	4.0	6.0	15.7	12.3	0.792	10.30.084.833.343.034.1012.412.9	0.299
ZF 250 x 2.5	250	80	70	25	22	2.5	2.5	10.8	8.45	0.866	12.10.142.833.373.034.1313.514.1	0.264
ZF 250 x 3.0	250	80	70	25	22	3.0	3.0	12.8	10.1	0.861	12.10.116.933.343.034.1313.514.1	0.262
ZF 250 x 4.0	250	80	70	25	22	4.0	6.0	16.7	13.1	0.842	12.10.054.913.252.924.1313.414.0	0.256
ZF 275 x 2.5	275	80	70	25	22	2.5	2.5	11.4	8.94	0.916	13.40.127.933.272.954.2714.515.3	0.230

ZF 275 x 3.0	275	80	70	25	22	3.0	3.0	13.6	10.6	0.911	13.40.104.993.252.994.2714.515.2	0.228
ZF 275 x 4.0	275	80	70	25	22	4.0	6.0	17.7	13.9	0.892	13.40.056.003.152.844.2314.515.1	0.223
ZF 300 x 2.5	300	80	70	25	22	2.5	2.5	12.0	9.43	0.966	14.50.118.073.132.854.3415.316.4	0.203
ZF 300 x 3.0	300	80	70	25	22	3.0	3.0	14.3	11.2	0.961	14.50.086.073.152.844.3515.716.4	0.201
ZF 300 x 4.0	300	80	70	25	22	4.0	6.0	18.7	14.7	0.942	14.50.056.033.072.754.3515.516.3	0.197

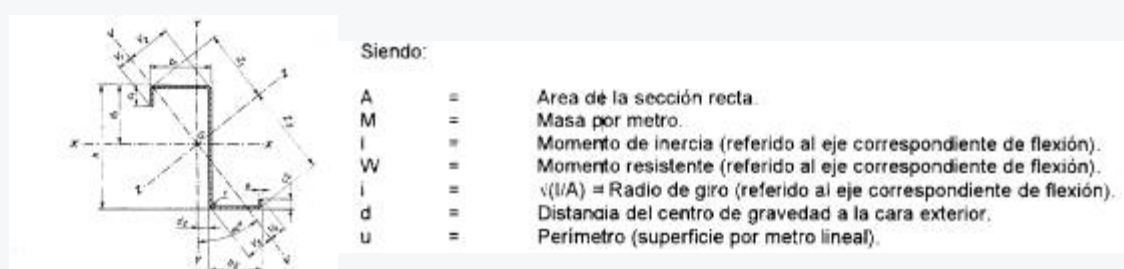
Tabla 5 16 Perfiles abiertos normalizados - Perfil Z - Momentos

PERFIL	Referido al eje X-X			Referido al eje Y-Y			I_{xy} cm ⁴	Referido al eje Z-Z			Referido al eje V-V		
	I_x	W_x	i_x	I_y	W_y	i_y		I_z	W_z	i_z	I_v	W_v	i_v
	cm ⁴	cm ³	cm	cm ⁴	cm ³	cm		cm ⁴	cm ³	cm	cm ⁴	cm ³	cm
ZF 100 x 2.0	76.4	14.7	4.02	40.8	12.2	2.94	42.8	105	14.6	4.72	12.3	3.94	1.61
ZF 100 x 2.5	93.5	18.0	4.00	49.3	14.7	2.91	52.0	128	17.9	4.68	14.9	4.78	1.60
ZF 100 x 3.0	109	21.0	3.97	56.8	16.6	2.87	60.3	149	21.0	4.64	17.2	5.51	1.58
ZF 120 x 2.0	117	18.8	4.77	40.8	12.6	2.82	52.2	143	18.2	5.29	14.2	4.29	1.67
ZF 120 x 2.5	143	23.0	4.75	49.3	15.1	2.79	63.5	175	22.4	5.25	17.2	5.21	1.65
ZF 120 x 3.0	167	26.9	4.72	56.8	17.1	2.75	73.8	204	26.3	5.21	19.9	6.01	1.63
ZF 140 x 2.0	167	23.1	5.50	40.8	12.9	2.72	61.6	192	22.3	5.90	15.7	4.56	1.69
ZF 140 x 2.5	205	28.4	5.48	49.4	15.6	2.69	75.1	235	27.4	5.87	19.1	5.54	1.67
ZF 140 x 3.0	240	33.2	5.44	56.9	17.5	2.65	87.2	275	32.2	5.83	22.0	6.39	1.65
ZF 160 x 2.0	228	27.7	6.21	40.8	13.2	2.63	71.1	252	26.8	6.53	17.0	4.78	1.69
ZF 160 x 2.5	281	34.0	6.19	49.4	15.9	2.59	86.6	310	32.9	6.50	20.6	5.80	1.67
ZF 160 x 3.0	330	40.0	6.15	56.9	17.9	2.56	101	363	38.8	6.45	23.8	6.70	1.65
ZF 180 x 2.0	302	32.6	6.91	40.9	13.5	2.54	80.6	325	31.6	7.17	18.0	4.95	1.69
ZF 180 x 2.5	371	40.1	6.88	49.4	16.1	2.51	98.1	399	38.9	7.13	21.8	6.01	1.67
ZF 180 x 3.0	436	47.1	6.85	56.9	18.3	2.47	114	468	45.8	7.09	25.3	6.94	1.65
ZF 200 x 2.0	472	45.8	7.85	97.3	23.8	3.56	159	531	44.1	8.32	39.1	8.39	2.26

125 x 2.5	125	2.5	5.99	4.70	142	33	21	6.60	4.87	2.35
125 x 3	125	3	7.12	5.59	167	40	25	8	4.84	2.37
150 x 2	150	2	5.34	4.19	178	27	23	5.50	5.77	2.25
150 x 2.5	150	2.5	6.61	5.19	218	33	28	6.70	5.75	2.25
150 x 3	150	3	7.87	6.20	257	40	33	8	5.72	2.25
175 x 2	175	2	6.10	4.79	273	34	31	7	6.69	2.37
175 x 2.5	175	2.5	7.56	5.94	336	43	38	8	6.66	2.37
175 x 3	175	3	9.01	7.10	397	51	44	10	6.64	2.38
200 x 2	200	2	7.50	5.90	464	88	45	11	7.86	3.43
200 x 2.5	200	2.5	9.31	7.31	572	109	56	14	7.84	3.42
200 x 3	200	3	11.11	8.72	677	130	66	17	7.81	3.42
200 x 4	200	4	14.59	11.45	876	174	85	22	7.75	3.45

Tabla 5.17. Perfiles abiertos normalizados - Correas - Correas Zetavor

Perfil	H	e	S	Peso	I_{xx}	I_{yy}	W_{xx}	W_{yy}	i_x	i_y
	mm	mm	cm ²	kg/m	cm ⁴	cm ⁴	cm ³	cm ³	cm	cm
225 x 2	225	2	8.00	6.28	610	88	53	12	8.74	3.32
225 x 2.5	225	2.5	9.91	7.88	751	109	65	14	8.70	3.28
225 x 3	225	3	11.83	9.46	890	127	77	17	8.67	3.28
225 x 4	225	4	15.55	12.60	1153	171	99	22	8.61	3.31
250 x 2	250	2	8.50	6.67	782	88	61	11	9.59	3.22
250 x 2.5	250	2.5	10.54	8.36	963	107	75	14	9.56	3.18
250 x 3	250	3	12.55	10.03	1138	125	89	16	9.52	3.15
250 x 3.5	250	3.5	14.52	11.70	1307	143	102	19	9.48	3.14
250 x 4	275	4	16.47	13.37	1470	165	115	22	9.45	3.16
275 x 2	275	2	9.00	7.10	968	109	70	13	10.40	3.48
275 x 2.5	275	2.5	11.20	8.80	1270	132	92	16	10.60	3.43

275 x 3	275	3	13.50	10.60	1541	133	112	16	10.60	3.14
275 x 4	300	4	18.00	14.20	2010	201	146	25	10.50	3.34
300 x 2	300	2	9.52	7.40	1266	107	84	13	11.50	3.35
300 x 2.5	300	2.5	11.90	9.30	1469	132	97	16	11.10	3.34
300 x 3	300	3	14.20	11.20	1889	133	125	16	11.50	3.06
300 x 4	300	4	18.90	14.80	2475	201	165	25	11.40	3.25
325 x 2.5	325	2.5	12.50	9.80	1925	132	118	16	12.40	3.25
325 x 3	325	3	15.00	11.70	2288	133	140	16	12.30	2.97
325 x 4	325	4	20.00	15.80	2897	189	178	23	12.00	3.07

CORREAS CEZETA



Tabla 5 18 Perfiles abiertos normalizados - Correas - Correas Cezeta

Perfil	H mm	e mm	S cm ²	Peso kg/m	I _{xx} cm ⁴	I _{yy} cm ⁴	W _{xx} cm ³	W _{yy} cm ³	i _x cm	i _y cm
100 x 2	100	2	4.75	3.73	77	18	15	4.30	4.02	1.92
100 x 2.5	100	2.5	5.87	4.61	93	21	18	5.20	3.99	1.91
100 x 3	100	3	6.96	5.46	109	25	21	6.00	3.96	1.89
125 x 2	125	2	5.25	4.12	129	18	20	4.30	4.95	1.85
125 x 2.5	125	2.5	6.49	5.10	157	22	25	5.20	4.92	1.83
125 x 3	125	3	7.71	6.05	184	25	29	6.00	4.89	1.81
150 x 2	150	2	5.75	4.51	197	18	26	4.30	5.86	1.78
150 x 2.5	150	2.5	7.12	5.59	241	22	32	5.20	5.82	1.76
150 x 3	150	3	8.46	6.64	284	26	37	6.10	5.79	1.74
175 x 2	175	2	6.25	4.90	284	18	32	4.30	6.74	1.72

175 x 25	175	2.5	7.74	6.08	348	22	39	5.20	6.70	1.70
175 x 3	175	3	9.21	7.23	409	26	46	6.10	6.67	1.68
200 x 2	200	2	6.75	5.30	389	19	39	4.30	7.60	1.66
200 x 2.5	200	2.5	8.37	6.57	478	22	47	5.20	7.56	1.64
200 x 3	200	3	9.96	7.82	564	26	56	6.10	7.53	1.62
225 x 2	225	2	7.25	5.69	516	19	46	4.30	8.44	1.61
225 x 2.5	225	2.5	8.99	7.06	635	23	56	5.20	8.40	1.59
225 x 3	225	3	10.71	8.41	750	27	66	6.10	8.37	1.57
250 x 2	250	2	7.75	6.08	666	19	53	4.30	9.27	1.56
250 x 2.5	250	2.5	9.62	7.55	820	23	65	5.20	9.23	1.54
250 x 3	250	3	11.46	9.00	969	27	77	6.10	9.20	1.53

CORREAS ZETA

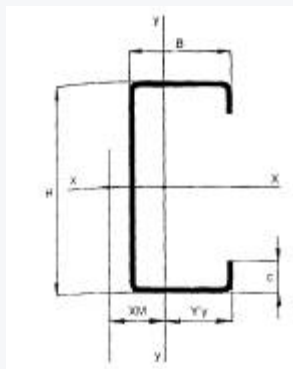

Tabla 5 19 Perfiles abiertos normalizados - Correos - Correos Zeta

Perfil	h mm	e mm	s cm ²	peso kg/m	i _{xx} cm ⁴	i _{yy} cm ⁴	w _{xx} cm ³	w _{yy} cm ³	i _x cm	i _y cm
200 x 2	200	2	7.50	5.90	474.29	47.42	7.95	90.43	10.89	3.27
200 x 2.5	200	2.5	9.31	7.31	585.23	58.52	7.92	112.22	13.55	3.47
200 x 3	200	3	11.11	8.72	701.91	70.19	7.94	133.14	16.13	3.46
200 x 4	200	4	14.59	11.45	925.09	92.50	7.96	194.36	23.70	3.65
225 x 2	225	2	8.00	6.28	625.51	55.60	8.84	90.43	10.9	3.27
225 x 2.5	225	2.5	9.9	7.88	777.41	69.10	8.86	112.22	13.58	3.47
225 x 3	225	3	11.83	9.46	926.70	82.37	8.85	133.16	16.14	3.46
225 x 4	225	4	15.55	12.60	1222.15	108.63	8.86	194.37	23.70	3.53

250 x 2	250	2	8.52	6.67	801.10	64.08	9.69	90.44	10.89	3.26
250 x 2.5	250	2.5	10.54	8.36	997.69	79.81	9.72	112.23	13.55	3.26
250 x 3	250	3	12.55	10.03	1189.97	95.19	9.73	133.15	16.14	3.26
250 x 4	275	4	16.47	13.37	1570.22	125.61	9.76	194.36	23.70	3.44
275 x 2	275	2	9.00	7.10	1006.64	73.21	10.57	90.44	10.90	3.17
275 x 2.5	275	2.5	11.20	8.80	1251.96	91.05	10.57	112.23	13.55	3.16
275 x 3	275	3	13.50	10.60	1493.72	108.63	10.52	133.16	16.14	3.14
275 x 4	300	4	18.00	14.20	1972.01	143.42	10.46	194.40	23.70	3.28

CORREAS CEBRAU

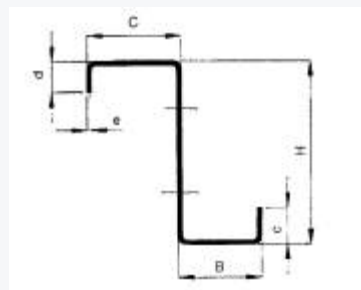

Tabla 5 - 20 Perfiles abiertos normalizados - Correas - Correas Cebrau

Perfil	H	e	S	Peso	I _{xx}	I _{yy}	W _{xx}	W _{yy}	i _x	i _y
	mm	mm	cm ²	kg/m	cm ⁴	cm ⁴	cm ³	cm ³	cm	cm
100 x 2	100	2	4.33	3.40	69.10	14.94	13.82	4.56	3.99	1.85
100 x 2.5	100	2.5	5.33	4.18	83.78	17.84	16.75	5.44	3.96	1.82
100 x 3	100	3	6.29	4.94	97.46	20.43	19.49	6.22	3.93	1.80
125 x 2	125	2	4.83	3.79	116.20	16.13	18.59	4.68	4.90	1.82
125 x 2.5	125	2.5	5.95	4.67	141.35	19.27	22.61	5.59	4.87	1.79
125 x 3	125	3	7.04	5.53	164.97	22.08	26.39	6.40	4.83	1.77
150 x 2	150	2	5.33	4.18	178.39	17.09	23.78	4.77	5.78	1.79
150 x 2.5	150	2.5	6.58	5.16	217.53	20.43	29.00	5.70	5.74	1.76
150 x 3	150	3	7.79	6.12	254.52	23.41	33.93	6.53	5.71	1.73
175 x 2	175	2	5.83	4.57	257.26	17.89	29.40	4.84	6.64	1.75
175 x 2.5	175	2.5	7.20	5.65	314.28	21.38	35.91	5.78	6.60	1.72
175 x 3	175	3	8.54	6.71	368.43	24.31	42.10	6.63	6.56	1.69

Tabla 5.20. Perfiles abiertos normalizados - Correas – Correas Cebrau

Perfil	H mm	e mm	S cm ²	Peso kg/m	I _{xx} cm ⁴	I _{yy} cm ⁴	W _{xx} cm ³	W _{yy} cm ³	i _x cm	i _y cm
200 x 2	200	2	7.67	6.02	466.45	60.03	46.64	11.53	7.79	2.79
200 x 2.5	200	2.5	9.33	7.33	573.14	64.50	57.31	12.12	7.83	2.62
200 x 3	200	3	11.10	8.71	676.12	85.61	67.61	16.13	7.80	2.77
200 x 4	200	4	14.54	11.41	870.46	99.80	87.04	18.78	7.73	2.61
225 x 2	225	2	8.17	6.41	614.20	62.30	54.59	11.66	8.66	2.76
225 x 2.5	225	2.5	9.96	7.82	755.42	69.17	67.14	12.69	8.70	2.63
225 x 3	225	3	11.85	9.30	892.02	82.55	79.29	15.18	8.67	2.63
225 x 4	225	4	15.54	12.20	1150.74	103.49	102.28	19.02	8.60	2.59
250 x 2	250	2	8.67	6.87	787.06	64.30	62.96	11.78	9.52	2.72
250 x 3	250	3	10.58	8.31	968.83	71.60	77.50	12.87	9.56	2.60
250 x 3.5	250	3.5	12.60	9.89	1154.35	85.13	92.34	15.34	9.56	2.59
250 x 4	275	4	16.54	12.98	1479.60	106.75	118.36	19.22	9.45	2.53
275 x 2	275	2	9.0	7.08	1000.70	63.64	72.70	11.32	10.50	2.65
275 x 2.5	275	2.5	11.2	8.85	1242.40	74.20	90.30	13.20	10.50	2.56
275 x 3	275	3	13.6	10.62	1481.80	91.46	107.27	16.27	10.40	2.59
275 x 4	300	4	18.0	14.16	1938.0	116.83	111.70	20.82	10.30	2.54
300 x 2	300	2	9.5	7.47	1248.20	65.14	83.20	11.38	11.40	2.61
300 x 2.5	300	2.5	11.9	9.34	1549.80	79.53	103.30	13.92	11.40	2.58
300 x 3	300	3	14.2	11.20	1847.70	93.60	123.20	16.39	11.30	2.56
300 x 4	300	4	19.0	14.90	2388.0	119.55	159.20	20.97	11.10	2.50

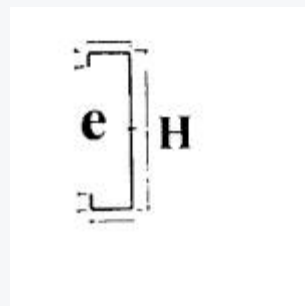

Tabla 5 21 Perfiles abiertos normalizados - Correas - Correas Sigma

Perfil	H mm	e mm	S cm ²	Peso kg/m	I _{xx} cm ⁴	I _{yy} cm ⁴	W _{xx} cm ³	W _{yy} cm ³	i _x cm	i _y cm
160 x 2	160	2	7.02	5.49	304.90	38.11	6.59	29.20	6.04	1.91
160 x 2.5	160	2.5	8.75	6.86	355.02	44.40	6.36	32.76	7.28	1.98
160 x 3	160	3	10.40	8.24	432.64	54.08	6.24	36.93	8.20	1.82
180 x 2	180	2	7.40	5.80	388.22	43.13	7.24	27.41	6.05	1.92
180 x 2.5	180	2.5	9.25	7.26	479.61	53.29	7.20	33.03	7.29	1.73
180 x 3	180	3	11.10	8.71	553.54	61.50	7.00	38.62	8.52	1.86
200 x 2	200	2	7.97	6.12	495.66	49.56	7.79	27.57	6.03	1.85
200 x 2.5	200	2.5	9.75	7.65	615.06	61.50	7.94	33.23	7.27	1.84
200 x 3	200	3	11.70	9.18	729.58	72.95	7.89	38.31	8.38	1.81
200 x 4	200	4	15.60	12.24	952.00	95.20	7.81	47.43	10.42	1.74
220 x 2	220	2	8.20	6.43	620.30	47.30	8.68	27.74	6.03	1.83
220 x 2.5	220	2.5	10.25	8.04	762.92	69.35	8.65	33.41	7.26	1.80
220 x 3	220	3	12.30	9.65	913.28	83.02	8.61	38.51	8.37	1.77
220 x 4	220	4	16.40	12.87	1193.06	108.46	8.53	47.86	10.40	1.71
250 x 2	250	2	8.80	6.90	839.84	67.18	9.77	28.48	6.13	1.80
250 x 2.5	250	2.5	11	8.63	1039.49	83.16	9.72	33.64	7.44	1.74
250 x 3	250	3	13.20	10.36	1236.22	98.89	9.67	38.78	8.35	1.72
250 x 4	275	4	17.60	13.81	1588.02	122.04	9.50	47.94	10.37	1.65

5.1.8. TOLERANCIAS PARA PERFILES ABIERTOS CONFORMADOS EN FRÍO, UNE 36-

570-78, UNE 36-570-80 ERRATUM.

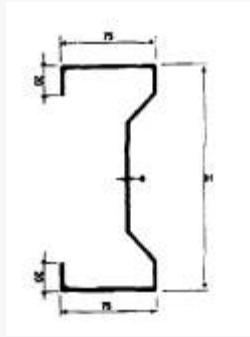
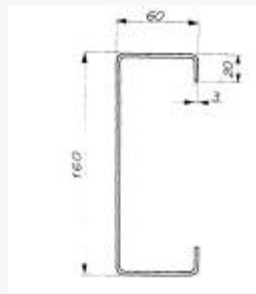

Tolerancias transversales: No existen valores generales para las tolerancias en las medidas transversales que dependen de la anchura del desarrollo del perfil, de la forma, del espesor y de la posición de la dimensión de la medida. Las tolerancias deberán medirse en todos los casos a más de 250 mm de los extremos de una barra. Para los perfiles de forma más usual, éstas tolerancias se recogen en las siguientes tablas, y pueden servir de orientación para otras condiciones y perfiles.

Tabla 5 - 22 Perfiles abiertos conformados en frío - Tolerancias de una barra comprendida entre dos pliegues 1)

Espesor nominal mm	Tolerancia en milímetros		
	B ≤ 50	50 < B ≤ 100	100 ≤ B ≤ 200
1.5 a 2.9	± 0.60	± 0.75	± 1.00
3 a 4.9	± 0.75	± 1.00	± 1.25
5 a 6.9	± 1.00	± 1.25	± 1.50
7 a 8		± 1.50	± 1.75

1) Los ángulos entre dos lados consecutivos, iguales a 90° y la dimensión menor B de una rama comprendida entre dos pliegues es igual o superior a diez veces el espesor.

Tabla 5 - 23 Perfiles abiertos conformados en frío - Tolerancia de una rama comprendida entre un borde y un pliegue 1)

Espesor nominal mm	Tolerancia en milímetros		
	L ≤ 40	40 < L ≤ 80	80 < L < 100
1.5 a 2.9	± 0.60	± 0.75	± 1.00
3 a 4.9	± 0.75	± 1.00	± 1.25
5 a 6.9	± 1.00	± 1.25	± 1.50
7 a 8		± 1.50	± 1.75

1) La dimensión menor L de una rama que tenga un borde por extremo es igual o superior a cinco veces el espesor para aceros de alto límite elástico diez veces el espesor y la relación de longitudes de alas libres inferior o igual a dos.

La tabla de tolerancia de una rama comprendida entre un borde y un pliegue es aplicable a perfiles conformados con bobinas cizalladas. Para bandas con bordes brutos las tolerancias de la tabla de tolerancia de una rama comprendida entre un borde y un pliegue deben duplicarse. Cuando la longitud esté formada por varios tramos, la tolerancia se aplicará a la longitud total de forma que la tolerancia de la medida total no sea la suma de las tolerancias parciales.

Tolerancias angulares: La desviación angular admisible sobre el ángulo teórico del perfil viene expuesto en la siguiente tabla.

Tabla 5 - 24 Perfiles abiertos conformados en frío - Desviación angular

Longitud más corta de las dos ramas que forman el ángulo	Hasta 30 mm incluido	Superior a 30 hasta 50 mm incluido	Superior a 50 hasta 80 mm incluido	Superior a 80 hasta 120 mm incluido	Superior a 120

Desviación admisible	± 2°	± 1° 45'	± 1° 30'	± 1° 15'	1°
----------------------	------	----------	----------	----------	----

Tolerancias en los radios de acuerdo: Las tolerancias sobre los valores de los radios de plegado se indican en la siguiente tabla.

A lo largo de un mismo perfil la diferencia entre los radios de plegado máximo y mínimo queda limitada al valor absoluto de la tolerancia dada en la siguiente tabla.

Tabla 5 25 Perfiles abiertos conformados en frío - Tolerancia en los radios de plegado

Espesor nominal mm	Tolerancia mm
hasta 2.9	± 0.75
de 3 a 4.9	± 1.00
de 5 a 6.9	± 1.25
de 7 a 8	± 1.50

Tolerancia en el enderezado: La flecha máxima que puede presentar un producto apoyado sobre un mármol será 0.25% de la longitud del perfil.

Tolerancia de revirado: La tolerancia en el revirado para los perfiles usuales será de 1° por metro. Para otros perfiles, en especial, los perfiles asimétricos, esta tolerancia será fijada por el fabricante. El control se efectuará estando el producto colocado sobre un mármol con una de sus extremidades sujeta sobre él y de forma que la longitud mayor sea paralela al plano de descanso.

Tolerancias de longitud: Este apartado es aplicable a los perfiles solicitados a longitud fija. La tolerancia se indica en la siguiente tabla. Previo acuerdo esta tolerancia puede aplicarse toda en más o menos.

Tabla 5 26 Perfiles abiertos conformados en frío - Tolerancia en longitud (para corte a longitud fija)

Longitud nominal mm	Tolerancia mm
hasta 2 m	± 1
de 2.01 a 6.0	± 2
de 6.01 a 10.0	± 3
superior a 10.0	± 5

5.2. PERFILES ABIERTOS NO NORMALIZADOS

5.2.1. PERFIL Y ACCESORIOS DE PUERTA CORREDERA



Tabla 5 27 Perfiles abiertos no normalizados - Perfil y accesorios de puerta corredera

Referencia	A x B x e mm	Sección cm ²	P kg/m	Longitud barras M	Datos técnicos de la sección			
					t cm	J cm ⁴	W cm ³	i cm
Corredera 1. 5-PU-1	61 x 55 x 2.5	4.80	3.76	6	3.31	17.45	5.26	3.62
Corredera 2. 5-PU-6	40 x 40 x 1.5	1.99	1.59	6				

Fuente: Catálogos de diversos distribuidores y fabricantes

5.2.2. JUNQUILLOS

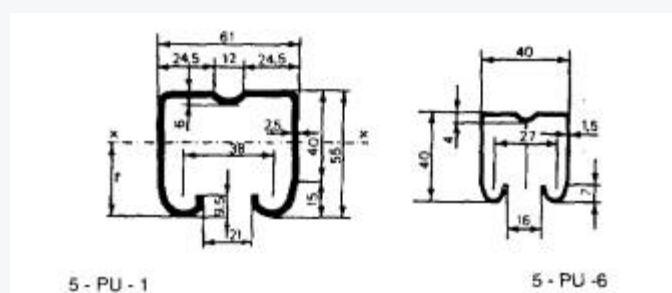

Tabla 5 28 Perfiles abiertos no normalizados - Junquillos

A x B x e mm	P kg/m	Referencia
12 x 10 x 0.8	0.21	5492
12 x 15 x 0.8	0.27	5518

5.2.3. VIERTEAGUAS

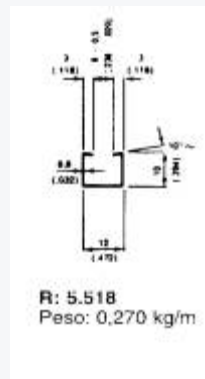

Tabla 5 29 Perfiles abiertos no normalizados - Vierteaguas

e mm	P kg/m	Referencia
1.5	0.55	5533

5.2.4. PERFIL INVERNADERO

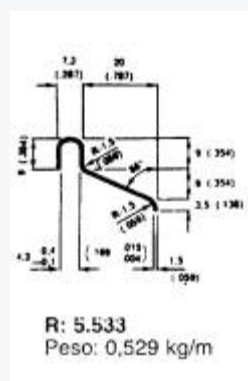

Tabla 5 30 Perfiles abiertos no normalizados - Perfil invernadero

A x B x e mm	P kg/m
25 x 38 x 1.5	1.46
30 x 44.5 x 1.5	1.80

Fuente: Catálogos de diversos distribuidores y fabricantes

5.3. PERFILES CERRADOS NO NORMALIZADOS

5.3.1. Simple pestaña



Tabla 5 31 Perfiles cerrados no normalizados - Simple pestaña

H x B mm	e mm	P kg/m	Referencias	Serie
35 x 15	1.5	1.410	5851	A
			PDS 4	
			PC-1	
40 x 30	1.5	1.860	6345	
			PDS 26	
			PA-1	
			Aleta 1	
50 x 35	1.5	2.308	PAC-28	
80 x 35			PAC-20	

50 x 20	2	2.470	5479	B
			CB-11	
50 x 40	2	3.240	5858	C
			PC-58	

5.3.2. Doble pestaña T

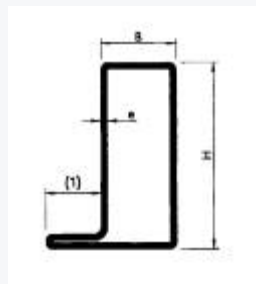

Tabla 5 32 Perfiles cerrados no normalizados - Doble pestaña T

H x B mm	e mm	P kg/m	Referencias	Serie
35 x 15	1.5	1.760	5852	A
			PDS-17	
			PA-2	
			PC-2	
40 x 30	1.5	2.210	PDS-41	
			Aleta 2	
50 x 20	2	2.860	5481	B
			CB-12	
50 x 40	2	3.850	5860	C
			PC-60	

Fuente: Catálogos de diversos distribuidores y fabricantes

5.3.3. Doble pestaña Z

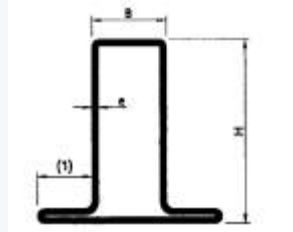

Tabla 5 33 Perfiles cerrados no normalizados - Doble pestaña Z

H x B mm	e mm	P kg/m	Referencias	Serie
35 x 15	1.5	1.760	5853	A
			PDS-21	
			PC-3	
50 x 20	2.	2.860	5482	B
			CB-13	
50 x 40	2	3.850	5859	C
			PC-59	

5.3.4. PERFILES ASIMÉTRICOS CERRADOS DE CARPINTERÍA

SERIE A

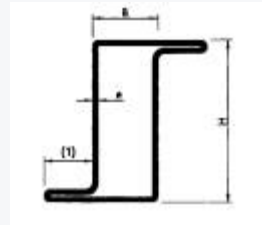
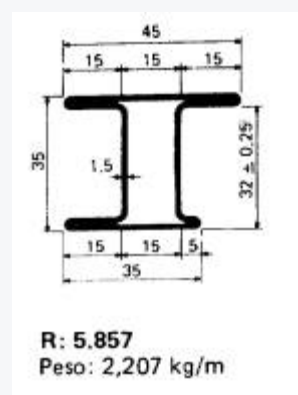
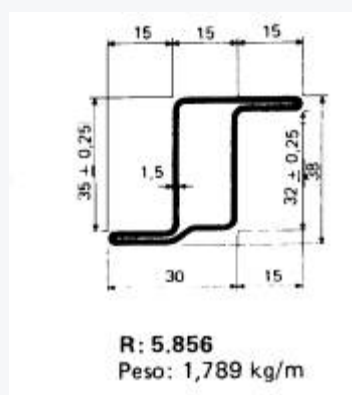
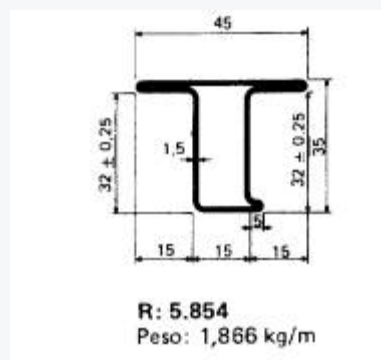
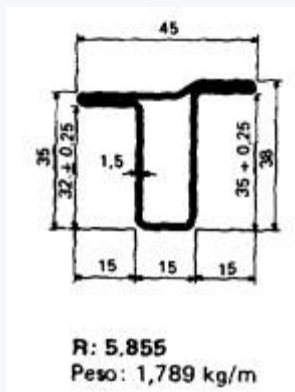

Fuente: Catálogos de diversos distribuidores y fabricantes

SERIE B

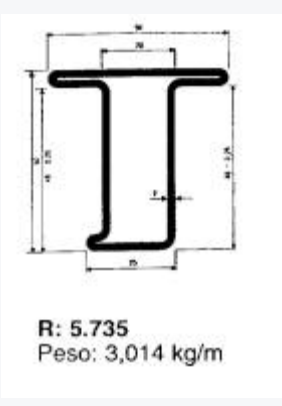
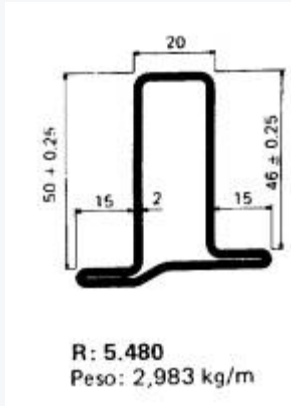

SERIE C



OTROS PERFILES:

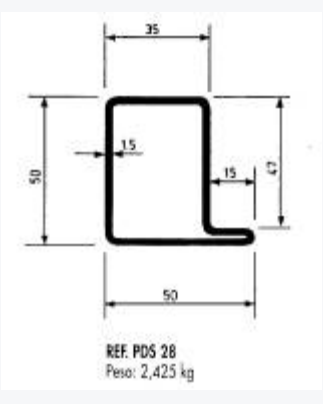
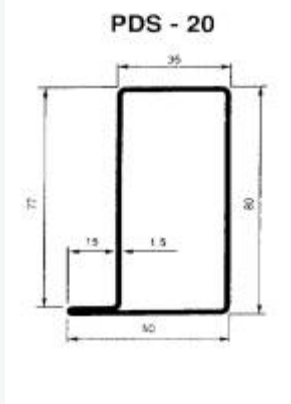
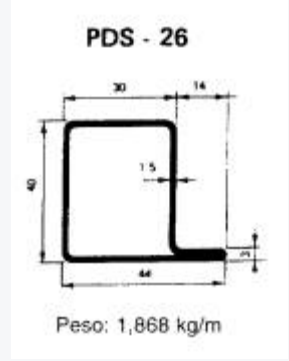

Fuente: Catálogos de diversos distribuidores y fabricantes

5.3.5. PASAMANOS



Tabla 5 34 Perfiles cerrados no normalizados - Pasamanos Simple

A x B mm	e mm	P kg/m
40 x 20	1.5	1.21
	2.5	1.95
50 x 25	1	1.03
	3	3.00
60 x 25	1	1.20

	2.5	2.87
--	-----	------

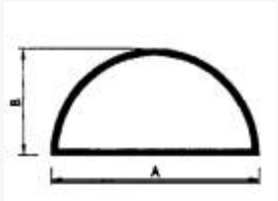

Tabla 5 35 Perfiles cerrados no normalizados - Pasamanos Decorativo

A x B mm	e mm	P kg/m
50 x 30	1	1.03
	1.5	1.50
	3	3.00

Fuente: Catálogos de diversos distribuidores y fabricantes

Índice de Tablas:

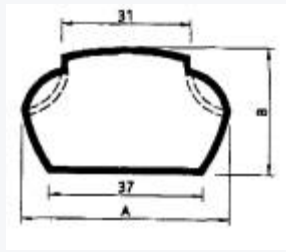
Perfiles de carpintería

TABLA 5 1 PERFILES ABIERTOS NORMALIZADOS - PERFIL L DE ALAS IGUALES - MEDIDAS

TABLA 5 2 PERFILES ABIERTOS NORMALIZADOS - PERFIL L DE ALAS IGUALES - MOMENTOS

TABLA 5 3 PERFILES ABIERTOS NORMALIZADOS - PERFIL L DE ALAS DESIGUALES - MEDIDAS

TABLA 5 4 PERFILES ABIERTOS NORMALIZADOS - PERFIL L DE ALAS DESIGUALES - MOMENTOS

TABLA 5 5 PERFILES ABIERTOS NORMALIZADOS - PERFIL U - MEDIDAS

TABLA 5 6 PERFILES ABIERTOS NORMALIZADOS - PERFIL U - MOMENTOS

TABLA 5 7 PERFILES ABIERTOS NORMALIZADOS - PERFIL C CUADRADO - MEDIDAS

TABLA 5 8 PERFILES ABIERTOS NORMALIZADOS - PERFIL C CUADRADO - MOMENTOS

TABLA 5 9 PERFILES ABIERTOS NORMALIZADOS - PERFIL C RECTANGULAR - MEDIDAS

TABLA 5 10 PERFILES ABIERTOS NORMALIZADOS - PERFIL C RECTANGULAR - MOMENTOS

TABLA 5 11 PERFILES ABIERTOS NORMALIZADOS - PERFIL N - MEDIDAS

TABLA 5 12 PERFILES ABIERTOS NORMALIZADOS - PERFIL N - MOMENTOS

TABLA 5 13 PERFILES ABIERTOS NORMALIZADOS - PERFILES OMEGA - MEDIDAS

TABLA 5 14 PERFILES ABIERTOS NORMALIZADOS - PERFILES OMEGA - MOMENTOS

TABLA 5 15 PERFILES ABIERTOS NORMALIZADOS - PERFIL Z - MEDIDAS

TABLA 5 16 PERFILES ABIERTOS NORMALIZADOS - PERFIL Z - MOMENTOS

TABLA 5 17 PERFILES ABIERTOS NORMALIZADOS - CORREAS - CORREAS ZETA VOR

TABLA 5 18 PERFILES ABIERTOS NORMALIZADOS - CORREAS - CORREAS CEZETA

TABLA 5 19 PERFILES ABIERTOS NORMALIZADOS - CORREAS - CORREAS ZETA

TABLA 5 20 PERFILES ABIERTOS NORMALIZADOS - CORREAS - CORREAS CEBRAU

TABLA 5 21 PERFILES ABIERTOS NORMALIZADOS - CORREAS - CORREAS SIGMA

TABLA 5 22 PERFILES ABIERTOS CONFORMADOS EN FRÍO - TOLERANCIAS DE UNA BARRA COMPRENDIDA ENTRE DOS PLIEGUES 1)

TABLA 5 23 PERFILES ABIERTOS CONFORMADOS EN FRÍO - TOLERANCIA DE UNA RAMA COMPRENDIDA ENTRE UN BORDE Y UN PLIEGUE 1)

TABLA 5 24 PERFILES ABIERTOS CONFORMADOS EN FRÍO - DESVIACIÓN ANGULAR

TABLA 5 25 PERFILES ABIERTOS CONFORMADOS EN FRÍO - TOLERANCIA EN LOS RADIOS DE PLEGADO

TABLA 5 26 PERFILES ABIERTOS CONFORMADOS EN FRÍO - TOLERANCIA EN LONGITUD (PARA CORTE A LONGITUD FIJA)

TABLA 5 27 PERFILES ABIERTOS NO NORMALIZADOS - PERFIL Y ACCESORIOS DE PUERTA CORREDERA

TABLA 5 28 PERFILES ABIERTOS NO NORMALIZADOS - JUNQUILLOS

TABLA 5 29 PERFILES ABIERTOS NO NORMALIZADOS - VIERTEAGUAS

TABLA 5 30 PERFILES ABIERTOS NO NORMALIZADOS - PERFIL INVERNADERO

TABLA 5 31 PERFILES CERRADOS NO NORMALIZADOS - SIMPLE PESTAÑA

TABLA 5 32 PERFILES CERRADOS NO NORMALIZADOS - DOBLE PESTAÑA T

TABLA 5 33 PERFILES CERRADOS NO NORMALIZADOS - DOBLE PESTAÑA Z

TABLA 5 34 PERFILES CERRADOS NO NORMALIZADOS - PASAMANOS SIMPLE

TABLA 5 35 PERFILES CERRADOS NO NORMALIZADOS - PASAMANOS DECORATIVO



Responsive Web Design

